

DIGITAL INDUSTRIES SOFTWARE

Simcenter 3D for structural simulation

Increasing realism and improving insight

Solution benefits

Reduce risk and cost while developing innovative structures

Investigate product performance virtually in all possible operating conditions, including thermally influenced operating conditions

Obtain more accurate solution results than linear analysis when standard linear assumptions are not valid

Improve confidence in final designs by virtually investigating your product's performance in all possible operating conditions

Simcenter™ 3D software for structural simulation offers a set of finite element (FE) structural solvers that are part of the Simcenter portfolio of simulation tools. They are used by engineers across industries as part of their product development process to evaluate the structural performance of their systems.

Providing finite element solution for experienced CAE analysts

Simcenter 3D for structures is powered by the well known Simcenter Nastran® software.

Structural solutions of Simcenter 3D offer scalable, open and extensible capabilities for both general and advanced analysts. They can be used on laptop, workstation and servers to solve everything from small models to the largest state-of-the-art industrial models.

Simcenter Nastran is available with enterprise licensing, which means it can be used independently from Simcenter pre/post solutions and can run on Windows and Linux operating systems.

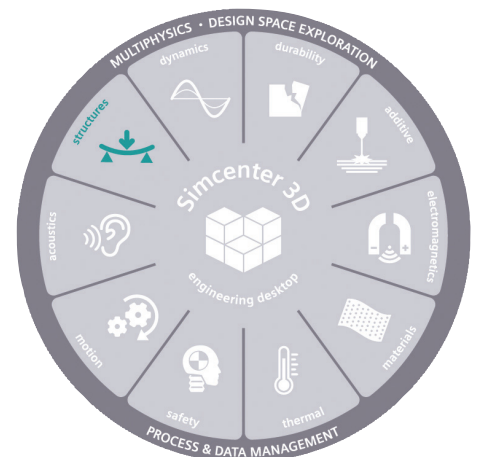

SIEMENS

[siemens.com/simcenter3d](https://www.siemens.com/simcenter3d)

Simcenter 3D for structural simulation

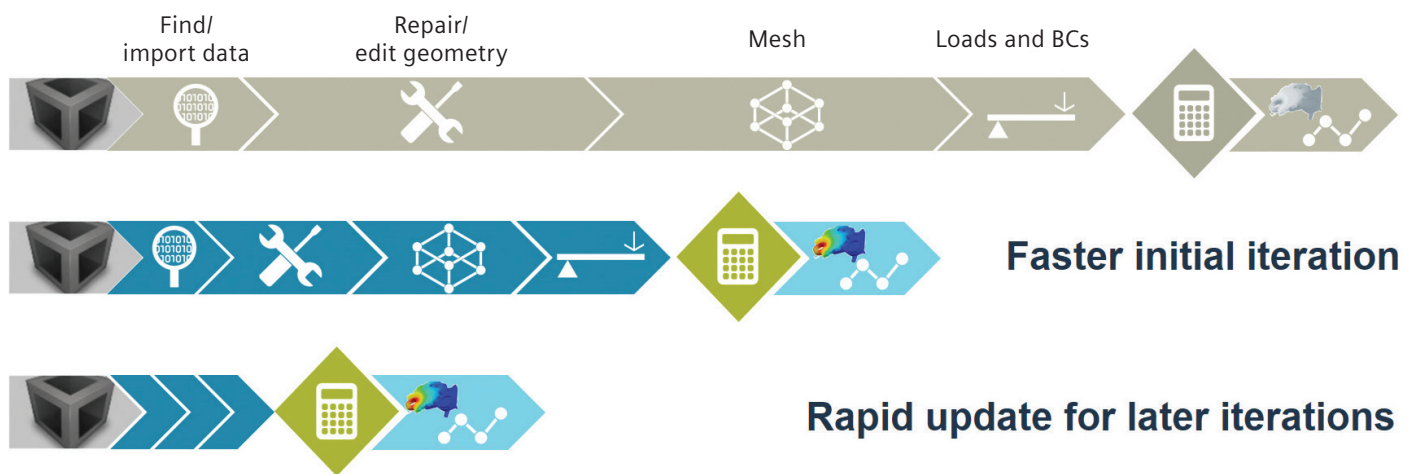

Reduce risk by using simulation to save time and cost

Simcenter 3D software addresses complex product engineering by delivering significant improvements in simulation efficiency. With advanced-capability 3D simulation technologies and powerful model preparation technology, Simcenter 3D offers new methods that increase realism and deliver better insight.

Accelerate innovation with rapid iterations

Synchronous technology in Simcenter 3D helps you reduce the time spent on model abstraction and geometry editing. Meshes, loads and boundary conditions are all associated with the base design, so when the design topology changes, you can rapidly update your simulation results. The solvers and analysis tools provide all the accuracy and speed you need for timely simulation-driven insights.

Investigate product performance virtually under all possible operating conditions

Simcenter 3D includes solvers that enable you to dive deep into the physics. Every application specialist will find state-of-the-art technology that fits the problem – static or dynamic, linear or nonlinear, composite or other, including temperature-dependant materials and thermal loads acting on a structure.

Co-simulation with Simcenter Nastran

Beyond structural solutions, Simcenter Nastran also enables co-simulation of structural, thermal and flow physics. A dedicated multiphysics environment allows you to define the complete solution on a single model, making co-simulation easily accessible to a broad set of users.

A platform for multidiscipline simulation

The Simcenter 3D structural simulation solution is part of a larger, integrated multidiscipline simulation environment with the Simcenter 3D Engineering Desktop at the core for centralized pre-/postprocessing for all Simcenter 3D solutions. This integrated environment helps you to achieve faster CAE processes and streamline multidiscipline simulations that integrate structural simulation with other disciplines like thermal simulation, fluid dynamics, multibody dynamics, or electromagnetics simulation.

Industry applications

Simcenter Nastran has helped manufacturers as well as engineering suppliers in many industries with their critical engineering computing needs so they can produce safe, reliable and optimized designs within increasingly shorter design cycles.

Airframe - Aerospace and defense - Aero engines

- Airplane frame – Stiffness, frame durability, modal frequency
- Wings – Stiffness, skin buckling, modal frequency
- Airplane hatch – Seals, structural strength
- Airplane pylons, ailerons, stabilizers – Stiffness, strength
- Satellite – Thermal stress and distortion, composites, modal frequency
- Launch vehicles – Thermal stress, maneuver loads, payload bracket loads
- Launch structures – Wind loads, launch loads
- Aero engines fans – Rotating loads, distortion, composites
- Aero engines compressor – Rotating loads, thermal stress and distortion, lifing, bolt stresses, cyclic symmetry, axisymmetry
- Aero engines turbines – Rotating loads, thermal stress and distortion, lifing, creep, cyclic symmetry, axisymmetry, break-out modeling
- Aero engines casing – Bearing loads, maneuver loads

Automotive – Ground vehicles

- Body – Roof crush, panel strength, stiffness, frame durability
- Powertrain/driveline – Torque loads, thermal stress and distortion
- Chassis – Harshness loads, suspension deflections
- Off-highway vehicles – Strength, durability, rollover protective structures (ROPs), stability
- Manufacturing tools – Thermal stress and distortion, modal frequency, bolted stresses
- Support structures – Stability, stress

Marine

- Full ships – Stiffness, deformation, strength
- Hulls – Skin rupture
- Bulkheads – Structural strength

Electronics

- Hand-held equipment – Drop simulation, plastic component stress
- Printed circuit boards (PCB) – Thermal stress and distortion, solder joint strength
- Electronic boxes – Bracket strength, modal frequency

Consumer goods

- Packaging – Strength, stability, hyperelasticity, creep

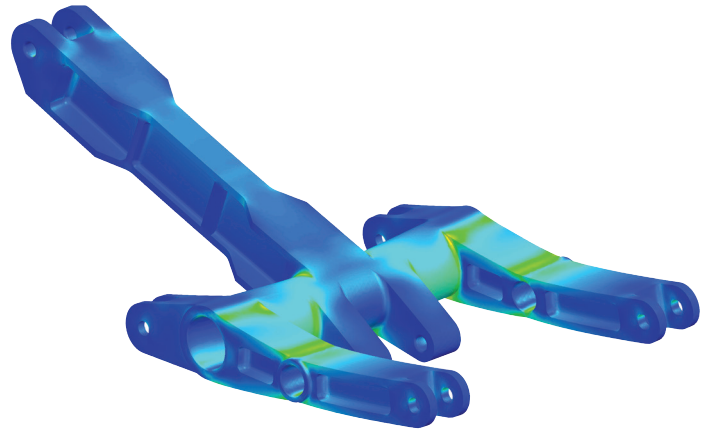

Simcenter 3D Structures

Simcenter 3D Structures software is a unified, scalable, open and extensible 3D computer-aided engineering (CAE) environment for simulation analysts. Simcenter 3D Structures is a bundle combining the Simcenter 3D Engineering Desktop, Simcenter Nastran environment and the Simcenter Nastran Basic solver. Together, Simcenter 3D Structures gives you best-in-class simulation modeling with the power to perform basic structural analysis with an industry-standard solver. The Simcenter 3D Engineering Desktop contained in Simcenter 3D Structures speeds the simulation process by helping you efficiently build the simulation model you need from 3D geometry faster than traditional CAE preprocessors. The integrated Simcenter Nastran solver in Simcenter 3D Structures lets you seamlessly submit analysis models for linear statics, normal modes, buckling and basic heat transfer analyses. Simcenter 3D Structures also forms the foundation on which you can add additional solutions for structural dynamics, multistep nonlinear, thermal, flow, acoustics, motion, optimization and multiphysics analyses, all from a single environment.

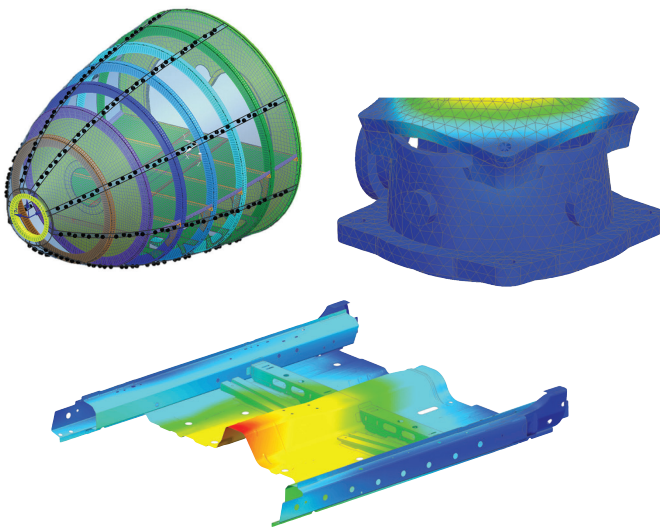

Module benefits

- Speed simulation processes by up to 70 percent
- Perform accurate, reliable structural analysis with the integrated Simcenter Nastran Basic solver
- Increase product quality by rapidly simulating design tradeoff studies
- Lower overall product development costs by reducing costly, late design change orders
- Efficiently manage large, complex analysis models
- Capture and automate best practices and commonly used processes
- Easily add multidiscipline simulation capabilities as your analysis needs grow

Key features

- All-inclusive software package with Simcenter 3D Engineering Desktop for pre/post together with Simcenter Nastran Basic for structural analysis
- NX is a leading geometry kernel which is used as part of Simcenter 3D to provide rapid geometry editing and abstraction
- Comprehensive meshing tools combined with efficient FE assembly management
- Immerses engineers in the Simcenter Nastran environment by using familiar terminology and extensive support of product-specific elements and entities
- Simulate structural analysis for linear statics, normal modes, buckling and heat transfer using the trusted Simcenter Nastran solver

Simcenter Nastran

Simcenter Nastran allows you to initiate digital simulation into your product development process by providing access to a broad library of finite element types and material models, robustly manipulating load cases and delivering several efficient solution sequences for analyses on models of unlimited size. You can also perform sensitivity studies based on these analysis types.

The Simcenter Nastran basic license comes with a full base set of structural capabilities as the entry point for Simcenter Nastran. It also comes with a basic heat transfer solver and the resulting temperatures can be used as loads in a structural solution.

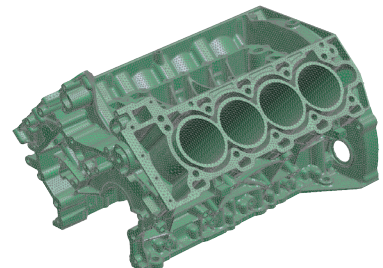
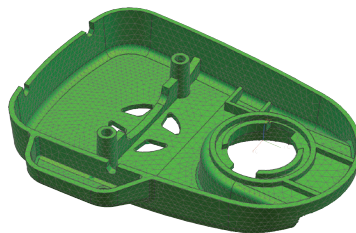
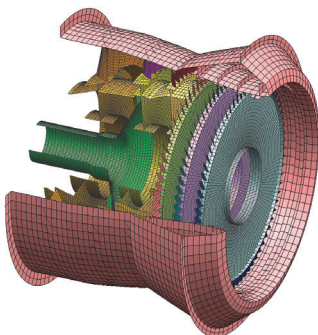
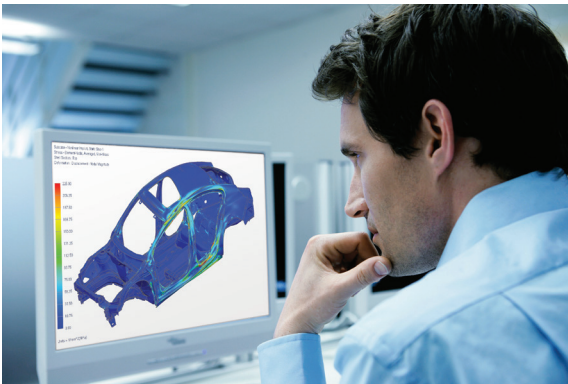

Module benefits

- Reduce risk by using simulation to save time and cost compared to physical test cycles
- Accelerate innovation with rapid iteration and numerous what-if studies
- Investigate product performance virtually under all possible operating conditions, including thermally influenced operating conditions

Key features

- Linear statics, normal modes, buckling
- Design sensitivity
- Basic nonlinear
- Composites
- Shared memory parallel (SMP) processing

Beyond the base set of capabilities, users can add more advanced structural capabilities including:

- Multistep nonlinear (static, transient)
- Distributed memory parallel (DMP) processing
- Linear dynamics (transient, frequency, random)
- Rotor dynamics
- Design and topology optimization
- Aeroelastic
- Vibroacoustic

Simcenter Nastran Multistep Nonlinear

Simcenter Nastran Multistep Nonlinear is an advanced solution that provides comprehensive capabilities for geometric nonlinear, contact, plasticity, creep, hyperelasticity and other material behaviors. The multistep solution allows users to set up sequential subcases for preload, nonlinear statics, nonlinear transient, modal, buckling, post buckling and harmonic modes.

This is an add-on product to a basic license that provides two nonlinear solution options: Simcenter Nastran solution SOL 401 and SOL 402. Both are suited to a similarly wide range of nonlinear problems, but each also has unique features.

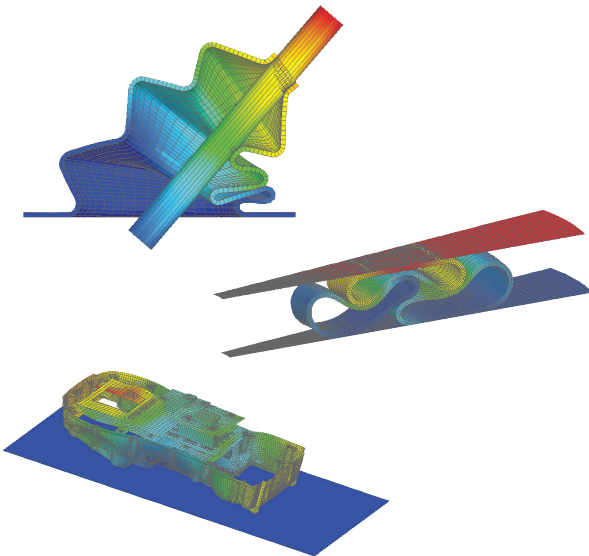

Module benefits

- Use the same models already built and analyzed linearly with Simcenter Nastran Basic
- Improve confidence in final designs by virtually investigating your product's performance under all possible operating conditions
- Obtain more accurate solution results than linear analysis when standard linear assumptions are not valid

Key features

- Static/dynamic analysis of models, including material and geometrical nonlinear behaviors
- Multistep solver allowing the following analysis types in different steps: static, dynamic, preload, modal, buckling, cyclic symmetry modes, Fourier harmonic modes
- Material nonlinear: hyperelasticity models (Mooney-Rivlin, Ogden, hyperfoam, Mullins effect, damping with Prony series), elastoplastic (Von Mises yield criterion, isotropic hardening, kinematic hardening, mixed hardening), thermal elastoplastic, creep, combined creep and elastoplastic
- Geometrical nonlinear: Large deformations, large strain, snap-through analysis (post buckling), follower forces
- Contact: Shell and solid element face contact, edge contact for axisymmetric modeling, single- and double-sided contact, self-contact, multiple friction models, tied contact, contact surface offsets, gap elements, contact activation/deactivation per subcase, contact pressures and force results, contact separation and sliding results

Simcenter Nastran DMP

Simcenter Nastran DMP is an add-on module to Simcenter Nastran Basic. It enables parallel processing using distributed memory. It is an efficient approach to solving large models and can be used on workstations with multiprocessors using Windows. DMP solutions are available for static solves (SOL 101), modal eigenvalue solves (SOL 103), modal dynamic response solves (SOL 111 and 112), direct frequency solves (SOL 108) and nonlinear solves (SOL 401 and SOL 402). DMP can also be used in combination with SMP, which comes as part of Simcenter Nastran Basic.

Module benefits

- More cores provide faster solutions
- Allows solving large models that are not possible to solve on a single central processing unit (CPU)

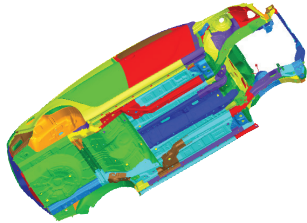
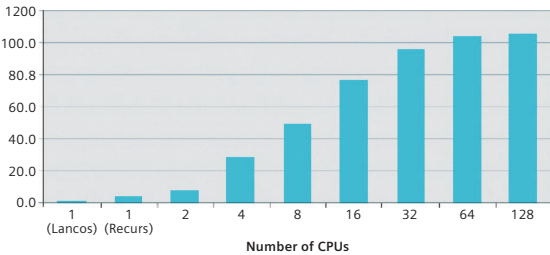
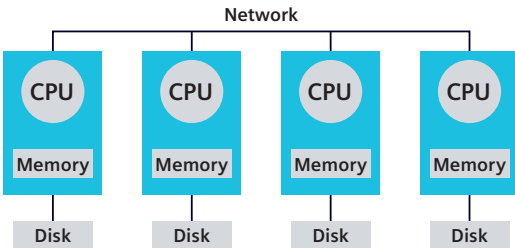
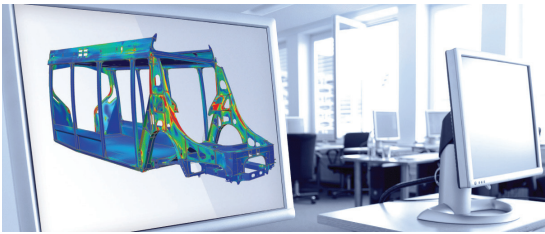

Capabilities chart

General capabilities	Specific capabilities	Simcenter 3D Structures	Simcenter Nastran Basic	
Linear structural solutions	Statics	•	•	
	Dynamics (see Simcenter 3D for structural dynamics for details)			
	Normal modes	•	•	
	Buckling	•	•	
	Restarts	•	•	
	Parallel memory processing	•	•	
	Elements			
	3D solids	•	•	
	2D solids	•	•	
	Shell	•	•	
	Membrane	•	•	
	Beam	•	•	
	Springs	•	•	
	Rods	•	•	
	Rigid	•	•	
	Composites			
	Short fiber	•	•	
	Long fiber	•	•	
	Connections			
	Bolt preloads	•	•	
	Contact connections	•	•	
	Glue connections	•	•	
	Materials			
	Isotropic	•	•	
	Orthotropic	•	•	
	Anisotropic	•	•	
	Temperature dependence	•	•	
	Loads/boundary conditions			
	Gravity	•	•	
	Force/moment	•	•	
	Pressure	•	•	
	Rotational	•	•	
Temperature	•	•		
Enforced motion	•	•		

General capabilities	Specific capabilities	Simcenter 3D Structures	Simcenter Nastran Basic	Simcenter Nastran Multistep Nonlinear	
Nonlinear structural solutions	Large displacement effect			•	
	Large strain effect			•	
	Contact	•	•	•	
	– Coulomb friction	•	•	•	
	– Other friction models			•	
	Nonlinear materials				
	Plasticity			•	
	– Temperature dependence			•	
	– Bilinear			•	
	– Multilinear			•	
	– Isotropic hardening			•	
	– Kinematic hardening			•	
	Creep			•	
	Hyperelastic material			•	
	Nonlinear elastic material			•	
	Gasket material			•	
	User defined material			•	
	Composite				
	Cohesive delamination			•	
	Progressive failure			•	
	Algorithms				
	Static nonlinear			•	
	Transient nonlinear			•	
	Thermal mechanical co-simulation			•	
	Fluid-structural co-simulation			•	
	Modal about nonlinear state			•	
	Complex modal about nonlinear state			•	
	Buckling about nonlinear state			•	
	Multistep			•	
	Arc-length			•	
	Cyclic symmetry modes			•	
	Multi-harmonic modes			•	
Restart			•		
Element add/remove			•		

General capabilities	Specific capabilities	Simcenter 3D Structures	Simcenter Nastran Basic	Simcenter Nastran Multistep Nonlinear
Nonlinear structural solutions <i>(continued)</i>	Loads/boundary conditions (for nonlinear analyses only)			
	Distributed force			•
	Fluid pressure penetration			•
	Initial stress/strain			•
	Geometry imperfections			•

Legend:

• = included in module

Note: Simcenter Nastran Multistep Nonlinear is an add-on module to either Simcenter 3D Structures or Simcenter Nastran Basic.

Siemens Digital Industries Software
[siemens.com/software](https://www.siemens.com/software)

Americas 1 800 498 5351
 Europe 00 800 70002222
 Asia-Pacific 001 800 03061910

For additional numbers, click [here](#).