

SIEMENS

DIGITAL INDUSTRIES SOFTWARE

Simcenter Femap

Powering today's most advanced engineering
simulation analysis environment

[siemens.com/simcenter](https://www.siemens.com/simcenter)

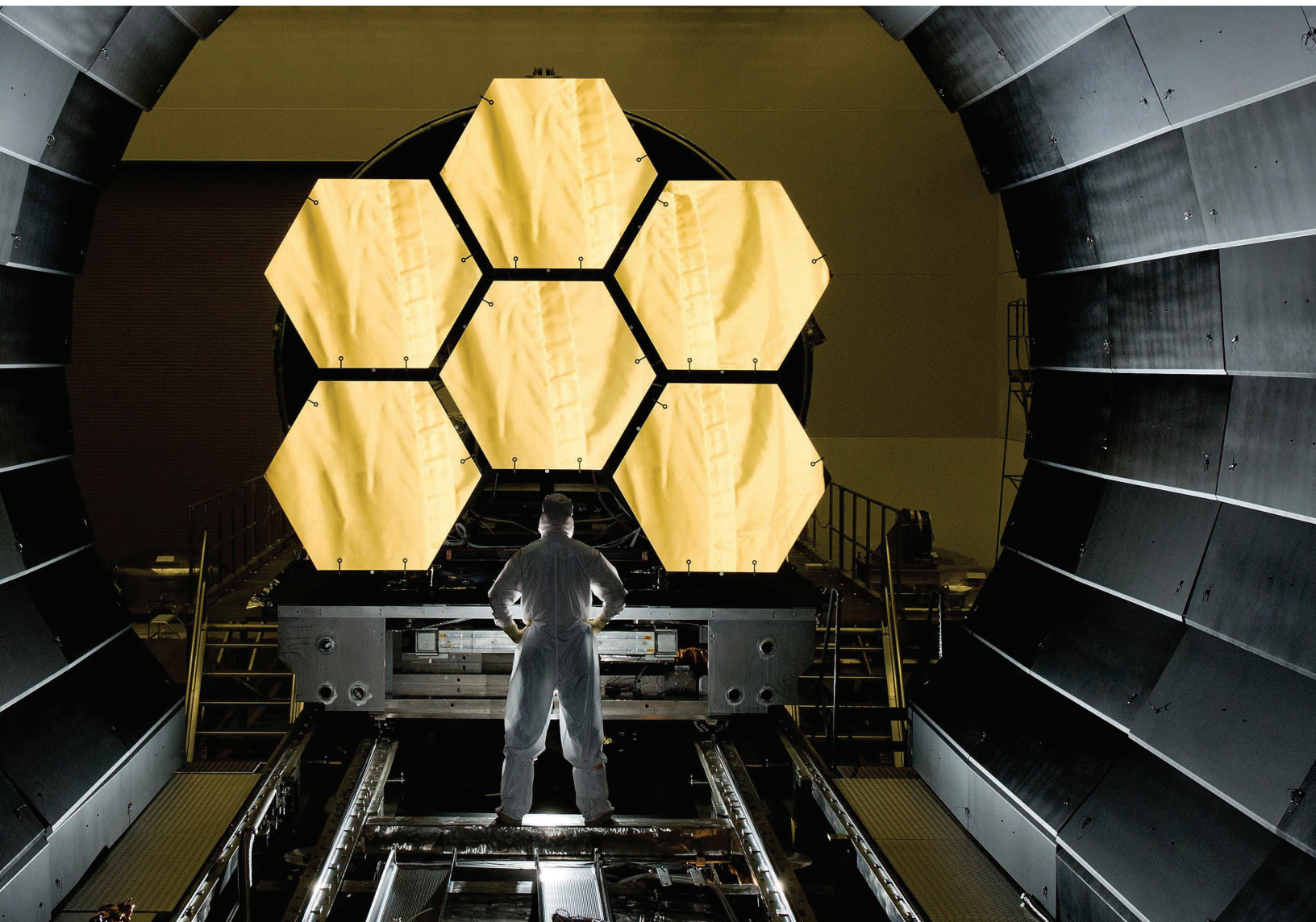

Best in class digital simulation

Why digital simulation?

Industry pressure to reduce costs and improve quality is driving growth in the use of digital simulation throughout the product lifecycle. Choosing the right tools is key to achieving the business benefits of digital simulation.

Why Simcenter Femap?

Siemens Digital Industries Software's Simcenter Femap™ system is a part of the Simcenter portfolio of simulation products and facilitates an advanced engineering analysis environment. CAD-neutral and solver-neutral technology and cost-effective functionality have enabled Simcenter Femap to become the world's most popular engineering analysis environment for NASTRAN users. It is widely used by the world's leading engineering organizations and consultants to model complex products, systems and processes, including rockets, satellites, aircraft, marine vessels defense, automotive vehicles, electronics, heavy construction equipment, lift cranes and process equipment.

Simcenter Femap with Simcenter NASTRAN® software are highly integrated and can be sold together as a bundled solution. But more than this, being open to all solvers, Simcenter Femap demonstrates the power and value as a core analysis tool.

Simcenter Femap is CAD-independent and leverages the Siemens Digital Industries Software Parasolid® modeling kernel that allows direct access to Parasolid data for surface and solid modeling in addition to advanced geometric tools necessary for accessing non-Parasolid geometry.

From advanced beam modeling, mid-surface extraction and hex meshing to robust CAD import and idealization, Simcenter Femap gives you

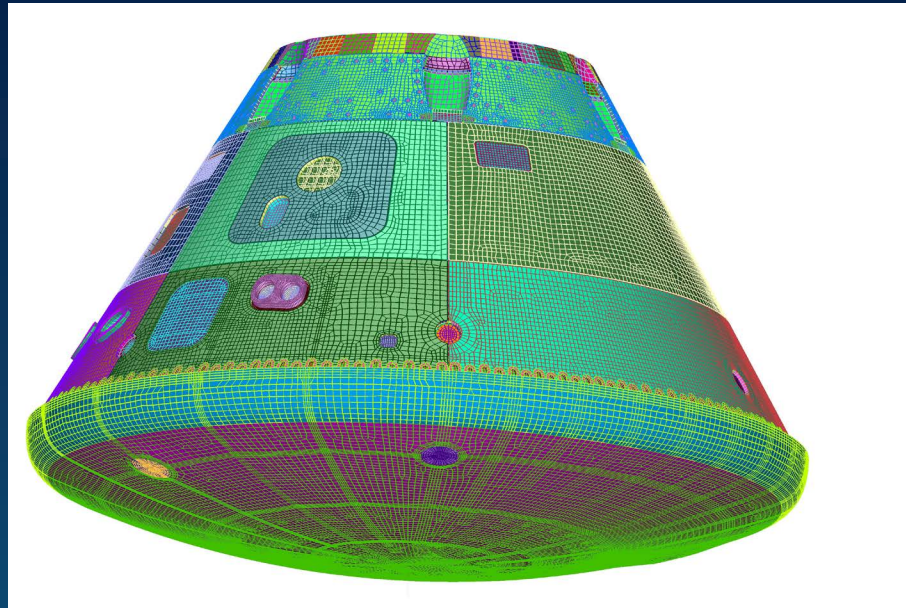

unparalleled model control and flexibility with a broad range of element types, materials, loads, analysis types and visualization options.

Simcenter Femap is not just a solid investment for those committed to excellence in the use of finite element analysis technologies – it's the right tool to help you realize your business goals.

Your business benefits

- Faster to market with innovative new products
- Lower cost through reduced physical prototyping, fewer engineering change orders and better in-service warranty
- Improved product quality

Simcenter Femap enables instant, secure collaboration between colleagues, partners and customers with Siemens' next-generation, cloud-based collaboration solution, Xcelerator Share.

FEA performance with ease-of-use

Inside front cover:
Courtesy of Lockheed
Martin Space Systems

Page 3: The modern
Windows-native user
interface provides a
flexible and customizable
analysis environment
for structural, thermal,
CFD and in-house
applications.

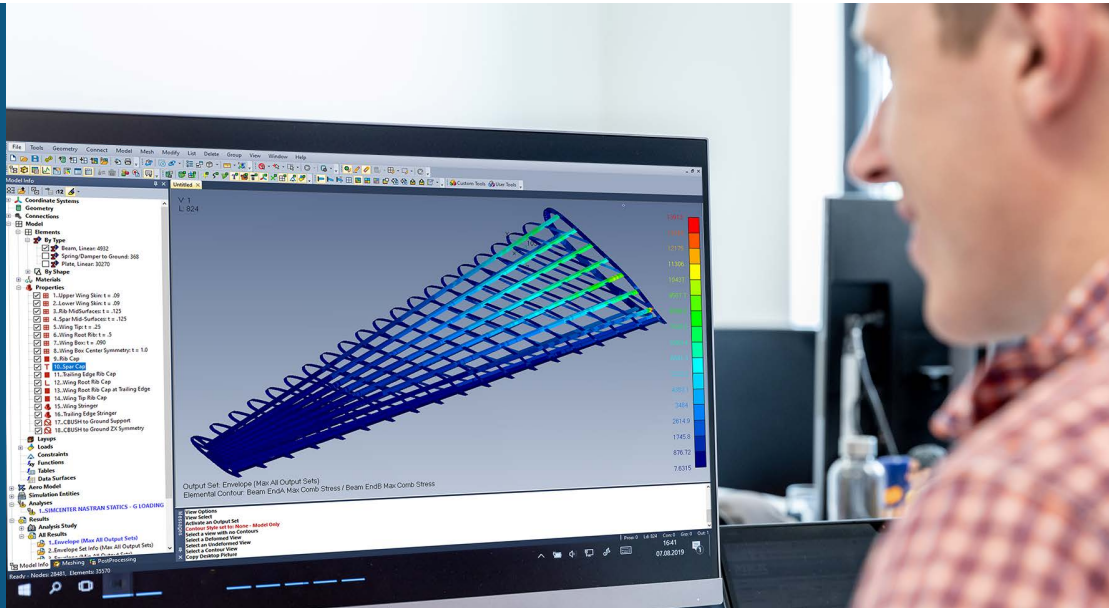

Simcenter Femap is recognized as the world's leading CAD-independent Windows-native pre- and postprocessor for advanced engineering finite element analysis (FEA). It provides engineers and analysts with a mesh-centric FEA modeling solution to handle even the most complex tasks with ease and accuracy.

Simcenter Femap has embodied the principles of power and simplicity for over 35 years and continues that focus today with a familiar Windows user interface and efficient workflows that simplify access to all Simcenter Femap functionality and streamline the process of creating an accurate and representative simulation model.

As an engineer, you demand software that is not only cost effective and easy to use, but with the power to model the toughest problem. Simcenter Femap delivers just that – affordable high-performance FEA modeling for the engineering desktop with the ease-of-use of a standard Windows application.



Simcenter Femap with Simcenter NASTRAN simplifies the product validation process. Reduced prototypes also lead to reduced costs and shorter development times. The design cycle has been reduced by 40 percent.”

Cui Zhongqin, Baotou Hydraulic Machinery

Solid Edge Simulation FloEFD Analysis

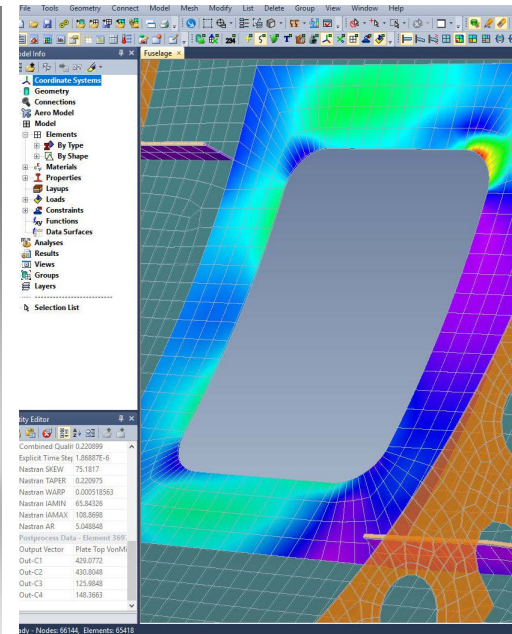
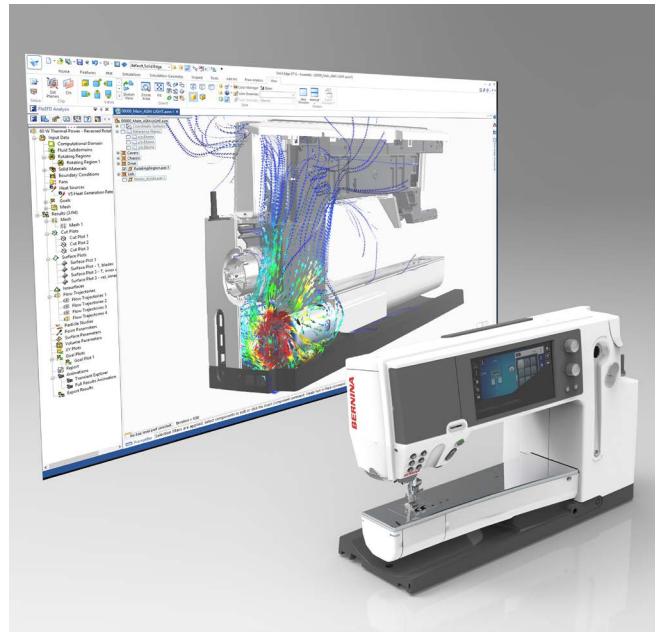

Scalable solutions

Powerful, affordable CAE

Simcenter Femap is available standalone or bundled with Simcenter NASTRAN with add-on modules that form a series of powerful, robust and affordable solutions suitable for companies that have a diverse set of analysis requirements. In addition, the analysis capabilities in Solid Edge Simulation are powered by Simcenter Femap. By providing engineering and design teams with advanced CAE tools, companies enable their engineers to focus on improving product performance and reliability while streamlining the product development process.

Simcenter Femap with Simcenter NASTRAN

The Simcenter Femap with Simcenter NASTRAN package seamlessly combines the advanced functionality of the Windows-native Simcenter Femap pre- and post-processor with the powerful Simcenter NASTRAN solver. Simcenter Femap with Simcenter NASTRAN allows engineers access to a much greater depth of analysis functionality to easily and efficiently solve complex engineering problems.

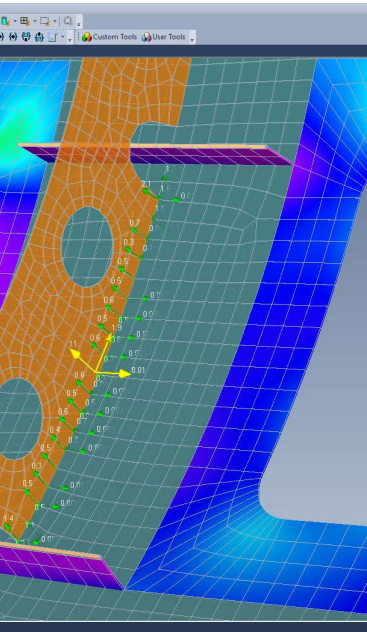

Additional Simcenter NASTRAN modules

A series of advanced Simcenter NASTRAN solution capabilities are available as add-on modules, providing engineering desktop solutions for even the most advanced NASTRAN analysis.

Proven solutions

By leveraging over 35 years of integration effort, Simcenter Femap with NASTRAN provides direct access right on the Windows engineering desktop to the most complete suite of NASTRAN capabilities available today. Siemens Digital Industries Software combines flexible licensing and packaging with “fair value” pricing to provide all engineering tool users with an affordable way to access the most advanced NASTRAN capabilities at an attractive total cost of ownership.



Creating advanced models that are both accurate and fast definitely gives us a competitive edge and has become a critically important contribution on these fast-paced, technically challenging spacecraft projects.”

Jeff Preble, SpaceWorks

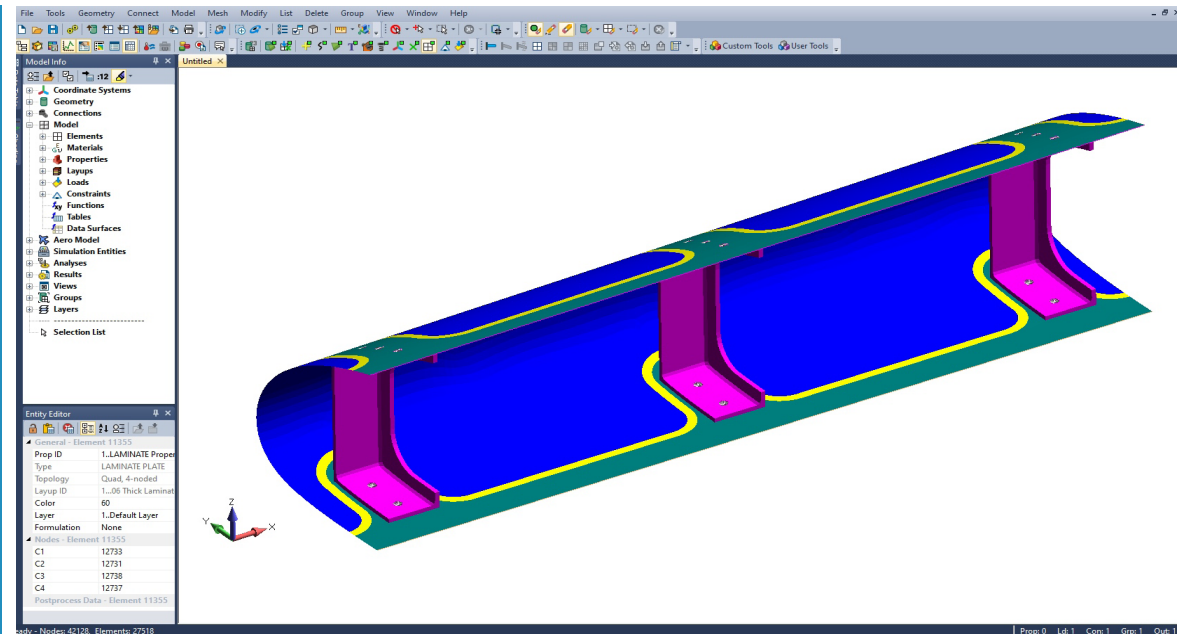

CAD independent

Serious engineering in a Windows environment

Simcenter Femap delivers great depth of functionality while at the same time providing unrivalled value to users. With powerful tools easing all aspects of the creation, manipulation and review of an engineering analysis model, Simcenter Femap is the natural choice for a complete CAD-independent analysis environment.

Simcenter Femap provides exceptional value and performance and is not limited to geometry-based digital data. Simcenter Femap will also delight customers working with pure finite element model data. As a nuts-and-bolts, “bottom up” finite element pre- and post-processing solution, Simcenter Femap provides a range of FEA model readers to rapidly import existing models from many FEA solvers. Advanced functionality then eases manipulation of finite element data at the node and element level.

The bottom line is that Simcenter Femap makes it possible to quickly create models that accurately predict the structural, dynamic and thermal performance of single components, assemblies or complex systems.

CAD independent

Simcenter Femap offers seamless geometry access with major CAD systems such as NX™ software, Solid Edge® software, PTC creo, CATIA, AutoCAD and SolidWorks. Along with direct import of geometry from these CAD Systems, Femap can also import Parasolid, STEP, IGES, and ACIS geometry files. Based on the industry-standard Parasolid geometry engine, Simcenter Femap offers extensive geometry creation and modification tools including standard wireframe curves, surface and solid modeling. Powerful shelling, blending, Boolean operations, surface imprinting and lofting combine to make Simcenter Femap extremely effective at creating or modifying geometry for analysis.

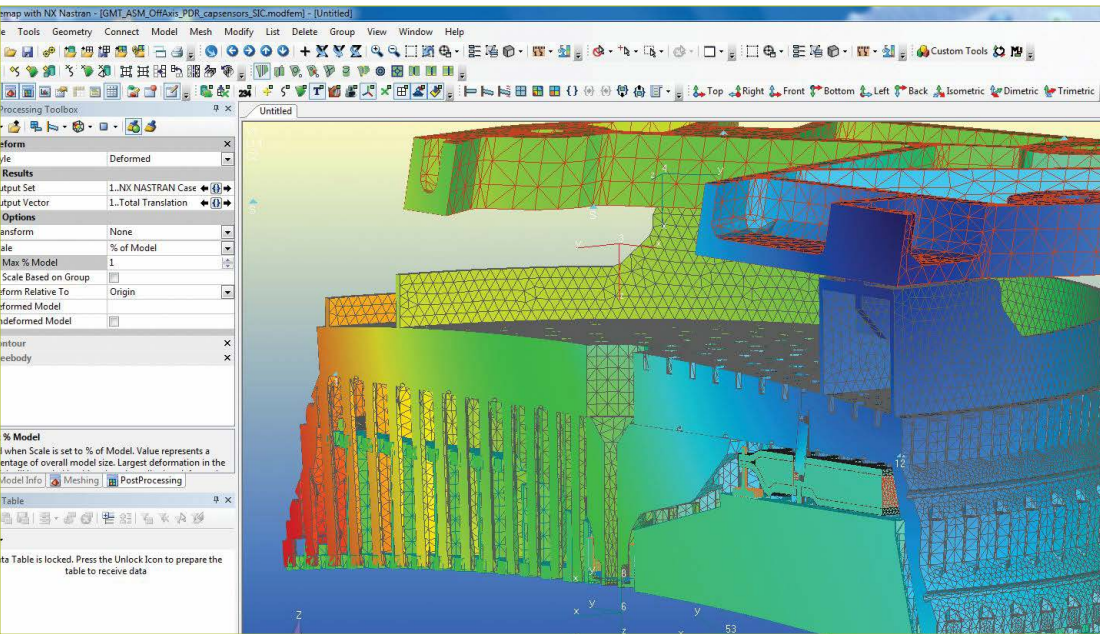

Reuse of legacy models

A long-standing bottleneck when attempting to reuse legacy models which do not contain geometry is the ability to update the existing mesh. This roadblock is eliminated in a number of ways, such as creating a new mesh by using an existing shell mesh as a starting point, allowing the mesh to be refined by subdividing existing elements, and allowing creation of surface geometry from a subset of existing elements.

The right geometry for analysis

Engineers often encounter geometry that is not ideal for analysis model definition. Simcenter Femap provides geometry creation and editing tools for curves, surfaces and solids, feature suppression and mid-surface extraction. Solids can be subdivided and automatically connected to represent dissimilar materials or to facilitate semi-automatic hexahedral mesh generation. Engineers can combine multiple surfaces to improve meshing areas for higher quality shell meshes.

Automatic assembly management

Simcenter Femap can automatically detect components of an assembly that are in contact. The method of connection, whether glued or contact (linear and nonlinear) is easily specified allowing rapid setup for assembly models.

A better mesh, faster than ever

Simcenter NASTRAN, MSC NASTRAN, Abaqus, ANSYS, LS-DYNA, MSC.Marc, ADINA, and TMG. You can also take over full control and work interactively with Simcenter Femap to manipulate the mesh or underlying geometry, while viewing element quality feedback live.

“
The significant meshing enhancements for hexa-elements in Simcenter Femap helped our productivity to increase by 30 percent or more. Even for difficult shapes, Simcenter Femap performs well. Without requiring a complicated operation, a good quality mesh can be obtained.”

Yuka Fukunaga
Analysis Technology Research
Center Sumitomo Electric
Industries

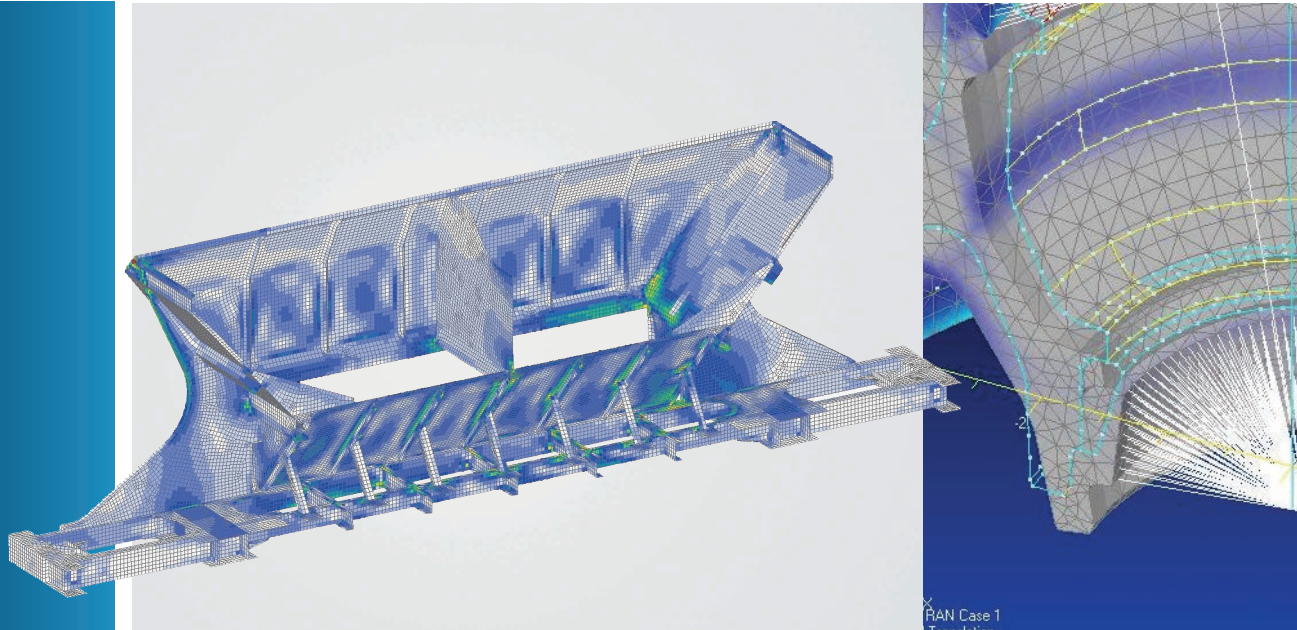

| Solver independent

Integrating analysis technologies

Leading firms recognize that a single analysis technology seldom meets all their requirements. By integrating multiple analysis technologies in a single modeling and visualization environment with Simcenter Femap, they can make better design decisions faster.

Analysis set manager

The analysis set manager in Simcenter Femap allows you to store solver setup data with your models, so you don't need to complete numerous dialog boxes each time you edit your model and create a new analysis input file. The sets can also be saved in a library for use with other models.

Multiple solver support

Simcenter Femap provides in-depth, high-quality support for industry standard solvers, including the popular and proven Simcenter NASTRAN, MSC NASTRAN, Abaqus, ANSYS, LS-DYNA, MSC. Marc, ADINA, and TMG.

Simcenter Femap provides the ability to re-use and integrate analysis models from legacy data as well as from customers and suppliers.

The complete Simcenter Femap element library, with comprehensive support of physical and material definitions, takes full advantage of the advanced capabilities of these solvers, including dynamic, geometric and material nonlinear, heat transfer and fluid flow applications.

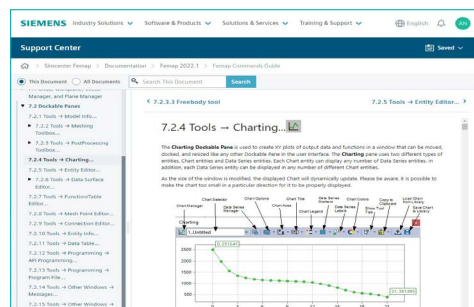

Easy-to-use online HTML and PDF documentation and help

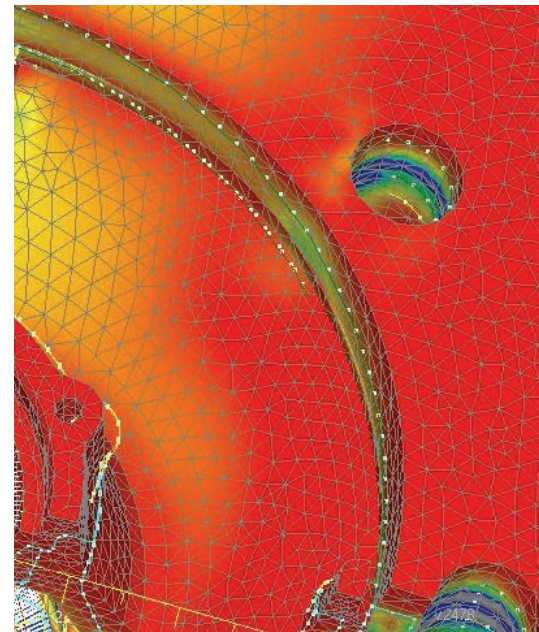
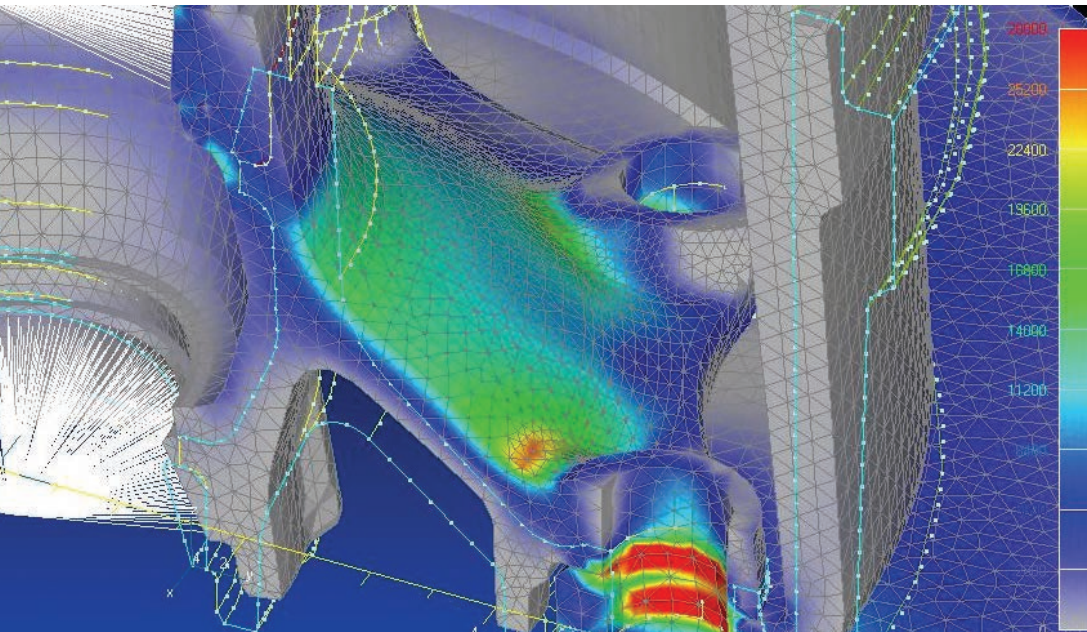

| Fully customizable

Integrated API Programming Environment

Simcenter Femap offers a full-featured Integrated Development Environment (IDE) in a separate window. Directly from the Simcenter Femap user interface, you can access the OLE/COM object-oriented Simcenter Femap application programming interface (API) that provides direct access to all Simcenter Femap objects and functionality. The API engine is fully OLE/COM compliant and can interface with Simcenter Femap as well as any OLE/COM compliant program such as Word or Excel. You can create custom programs that automate repetitive tasks, search model or results data, or programs that transfer model information to Word or Excel to create customized reports.

Many useful programs are delivered with Simcenter Femap in an ever expanding library, and can be found in the Custom Tools toolbar right in the user interface. These powerful customization capabilities allow complete access to Simcenter Femap full functionality through standard nonproprietary programming languages, and maintain Simcenter Femap as the industry's premier independent and open engineering environment.

Macro program files

In addition to the API programming capability, Simcenter Femap hosts a Program File capability in its own Simcenter Femap window. User-defined macros can be recorded, edited, debugged, and played back all within the Simcenter Femap interface.



The application of custom tools enabled us to reduce the time for developing finite element models and postprocessing analysis results by a factor of at least ten."

Chris Mairs
Cardinal Engineering

Flexible solution configurations

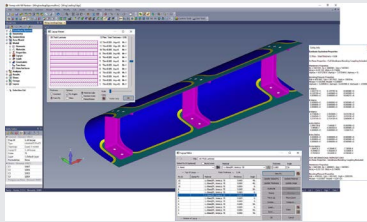

Simcenter Femap with Simcenter NASTRAN

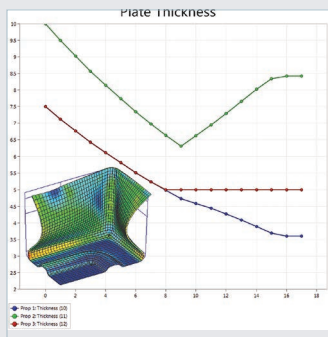

Optimization

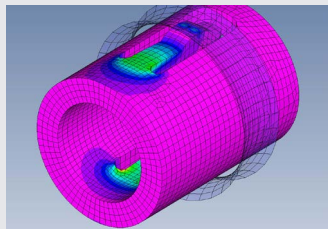

Multi-step nonlinear

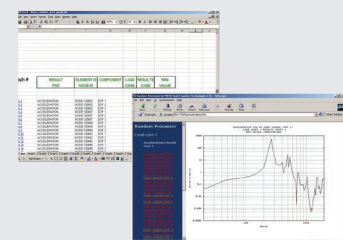

Structural analysis toolkit

Simcenter Femap with Simcenter NASTRAN

Provides all of the capabilities that you will need in many instances, including linear statics, normal modes, buckling, steady-state and transient heat transfer, basic nonlinear, design sensitivity and unlimited problem size capabilities.

Dynamic response

Enables product performance to be evaluated in both the time and frequency domains.

Optimization

Determine optimal design parameters with sizing and topology optimization capabilities.

Multi-step structural

Facilitates large deformation; supports nonlinear materials, time-dependent loads, deformable and rigid contact.

Multi-Step Nonlinear Kinematics

Offers many of the same capabilities as Multi-Step Structural with the addition of Kinematic Joints and Flexible Sliders used for Flexible Body Dynamics.

Structural analysis toolkit

Saves postprocessing time by organizing results data and calculating additional results quantities.

Aeroelasticity

Determine structural response from aerodynamic loading for static and flutter conditions.

Rotor dynamics

Predicts the dynamic response of rotating systems such as shafts, turbines and propellers to determine critical shaft speeds.

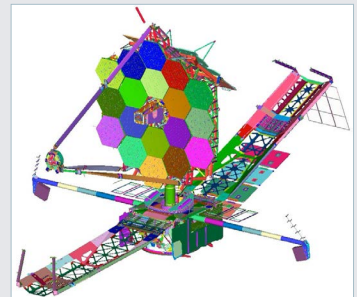

Dynamic response

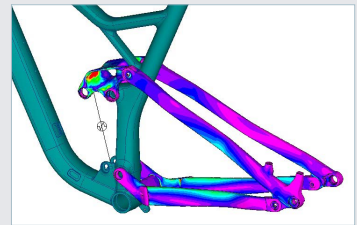

Multi-step Nonlinear Kinematics

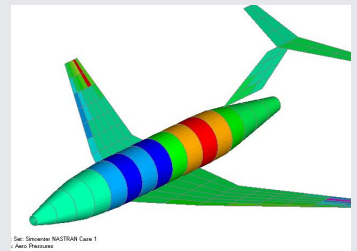

Aeroelasticity

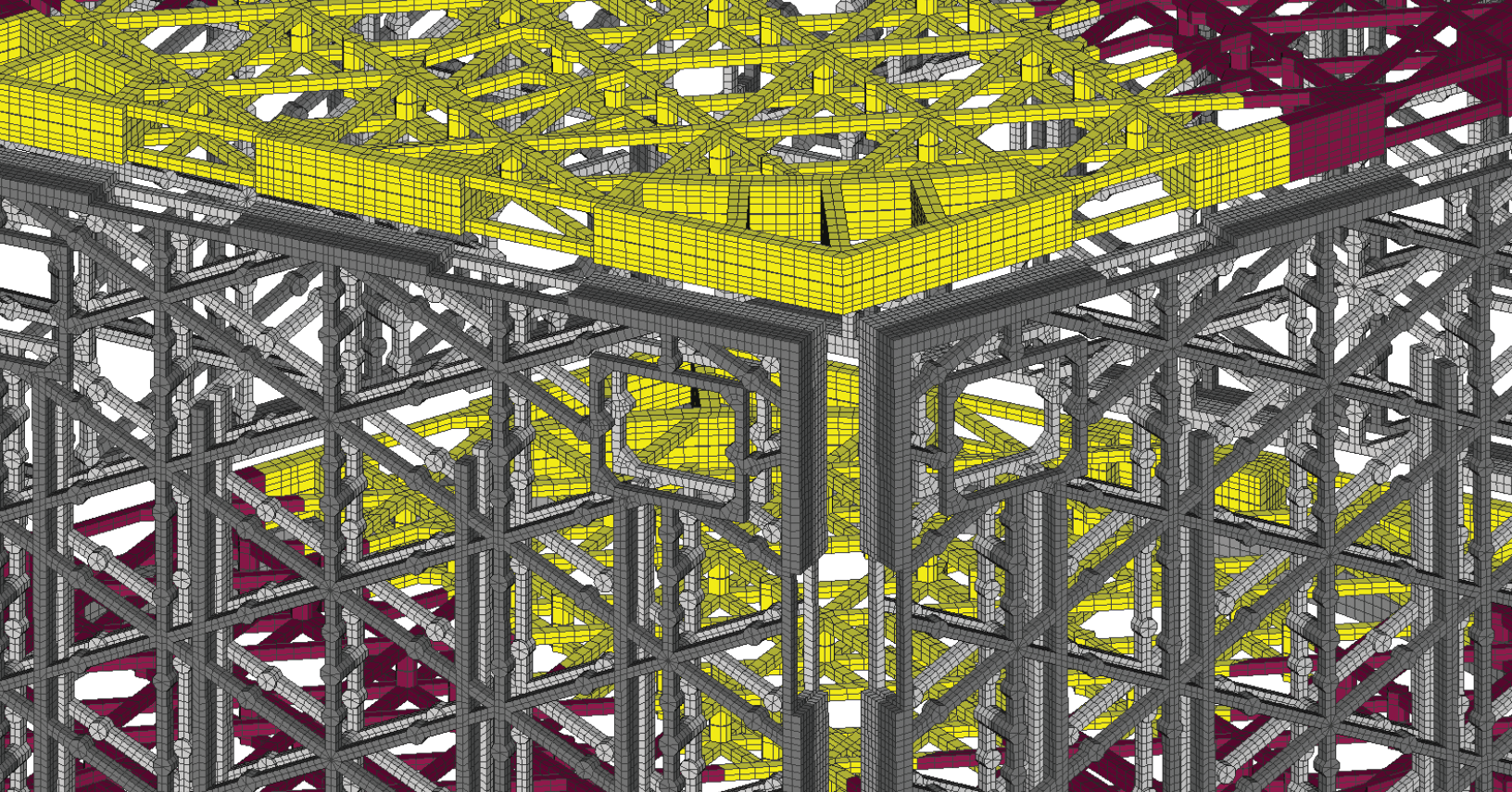

Simcenter NASTRAN and TMG analysis capabilities available with Simcenter Femap

	Simcenter Femap with Simcenter NASTRAN base module	Analysis extensions	Advanced bundle	License extension
Linear static	•		•	
Normal modes	•		•	
Buckling	•		•	
Heat transfer (steady-state and transient)	•		•	
Basic nonlinear	•		•	
Linear contact	•		•	
Glued connection	•		•	
Bolt preloads	•		•	
Dynamic response (transient and frequency)		•	•	
Design optimization		•		
Topology optimization		•		
Multi-step nonlinear		•		
Rotor dynamics		•		
Direct matrix abstraction programming (DMAP)			•	
Aeroelasticity			•	
Distributed memory parallel (DMP)			•	
Superelements			•	
Desktop extension				•
Simcenter Femap thermal solver		•		
Simcenter Femap advanced thermal solver		•		
Simcenter Femap flow solver		•		



Integrated multi-physics solvers for Simcenter Femap

Simcenter Femap Thermal

Simcenter Femap Thermal includes both the transient and steady-state thermal analysis capabilities required to solve a majority of common engineering problems. Capabilities include the modeling of conduction, convection, radiation and phase change. Simcenter Femap Thermal provides a range of thermal boundary conditions and solver controls as well as a powerful thermal modeling tool for assemblies. This thermal coupling capability allows users to create paths for heat to flow between parts in large, complex assemblies.

Simcenter Femap Advanced Thermal

Simcenter Femap Advanced Thermal adds many advanced thermal and fluid flow modeling capabilities to the Simcenter Femap Thermal package. For example, fluid duct flow modeling includes coupled convection and fluid flow analysis. An extensive set of tools for advanced radiation and spacecraft modeling includes solar and orbital heating, orbit modeling and display, specular reflections with ray tracing and articulating structures.

Simcenter Femap Advanced Thermal also provides advanced solver features such as custom user subroutines, model simplification, substructuring and interfaces to industry thermal codes.

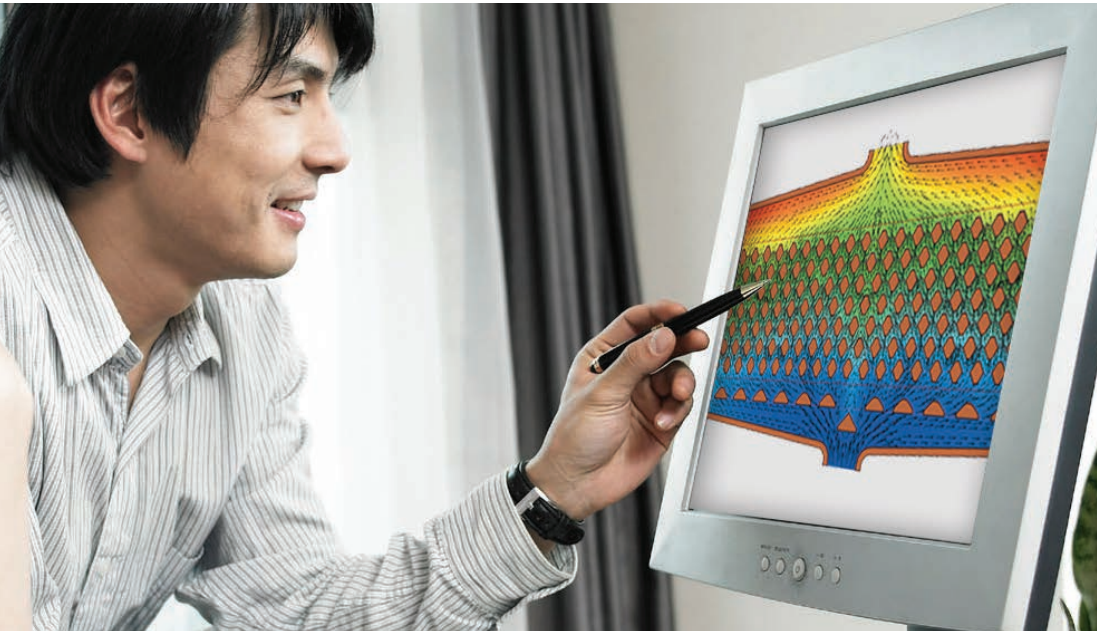

Simcenter Femap Flow

Simcenter Femap Flow provides a comprehensive 3D computational fluid dynamics (CFD) solution fully integrated within Simcenter Femap. When combined with Simcenter Femap Advanced Thermal, it solves a wide range of multi-physics problems that involve fluid flow and heat transfer. Both low-speed and high-speed compressible flows can be modeled. The Simcenter Femap Flow solver uses an efficient and robust element-based finite volume, multi-grid solver to compute 3D fluid velocity, temperature and pressure for both steady-state and transient applications.

Forced flow, natural convection and mixed flows can be modeled with multiple inlets, outlets and internal flow boundary conditions. For electronics cooling applications, the package easily models fan curves, inlet and outlet resistances as well as convection from thin structures. Rotating systems, moving walls, flow turbulence models, humidity and other features are available for the most advanced fluid flow modeling requirements.

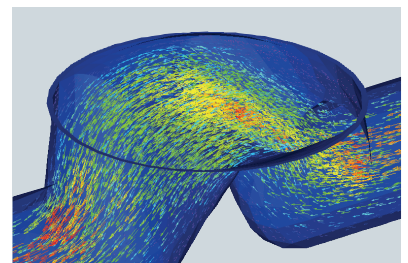
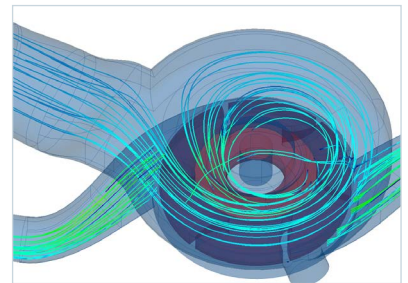

Where engineering meets tomorrow.

Simcenter Femap is a part of the Simcenter portfolio of simulation products.

We believe that the comprehensive digital twin is critical to the future of engineering innovation and that simulation and test are the beating heart of the digital twin. By providing you with insight into the real-world performance of your product or process, Simcenter allows you to accelerate innovation over the entire lifecycle.

Simcenter is a flexible, open and scalable portfolio of the best predictive simulation and test applications, that support customers at every step in their digital journey, to drive innovation into their products, and shorten time to market. Simcenter is a key component within Xcelerator, a comprehensive and integrated portfolio of software, services, and an application development platform that speeds digital transformation.

Becoming a Simcenter customer means more than purchasing world-class software or services; it opens the door to an unrivaled wealth of engineering expertise. Our technological solutions are backed by a global team of engineering specialists, dedicated to helping you meet the challenges of your industry and exceed the expectations of your market.

For additional information on Simcenter, please visit [siemens.com/simcenter](https://www.siemens.com/simcenter).

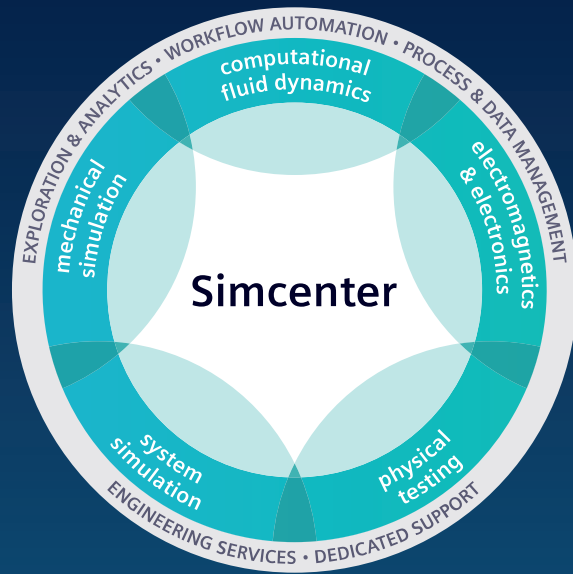

The Siemens advantage

Siemens Digital Industries Software's digital simulation applications are part of a broader portfolio that empowers development teams at the world's largest OEMs as well as thousands of the world's smaller companies. Value depends on the ability of solutions to scale, ensuring the right software is available to the right people and that specialists can leverage the work of the much wider development team.

Throughout its product portfolio, Siemens Digital Industries Software leverages key attributes that help companies achieve business objectives such as waste reduction, quality improvement, shorter cycle times and greater product innovation. These unique attributes directly support business process initiatives aimed at transforming product development:

Managed development environment

Full integration, synchronized management of all product data and process knowledge to transform product development with a structured collaborative environment.

Unified product development solution

Seamless integration of applications to rapidly propagate changes of product and process information, replacing point solutions with a unified development system, from concept to manufacturing.

Knowledge-driven automation

The application of product and process knowledge across all elements of product development to automate processes and maximize re-use.

Simulation, validation and optimization

Comprehensive simulation and validation tools to automatically check performance and manufacturability at every step of the development process for closed-loop, continuous, repeatable validation.

System-based modeling

Structured conceptual models standardized design practices that allow rapid creation of variants, transforming development from component-based design to a systems engineering approach.

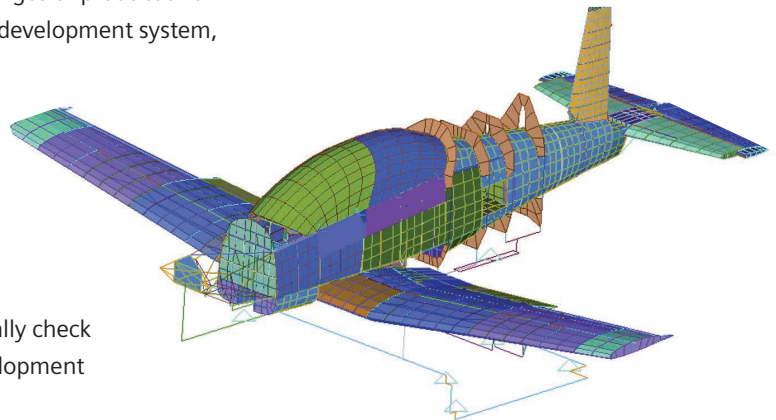
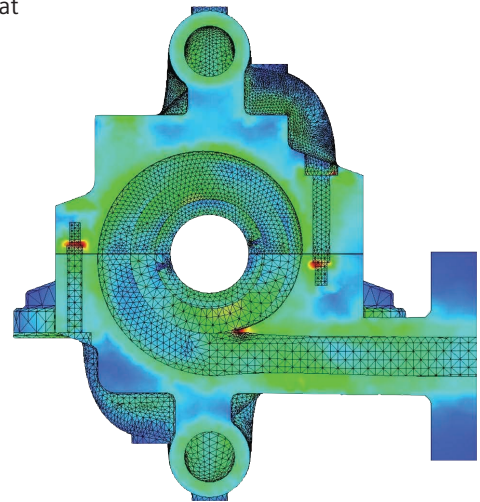

About Siemens Digital Industries Software

Siemens Digital Industries Software is driving transformation to enable a digital enterprise where engineering, manufacturing and electronics design meet tomorrow. Xcelerator, the comprehensive and integrated portfolio of software and services from Siemens Digital Industries Software, helps companies of all sizes create and leverage a comprehensive digital twin that provides organizations with new insights, opportunities and levels of automation to drive innovation. For more information on Siemens Digital Industries Software products and services, visit [siemens.com/software](https://www.siemens.com/software) or follow us on [LinkedIn](#), [Twitter](#), [Facebook](#) and [Instagram](#). Siemens Digital Industries Software – Where today meets tomorrow.

Americas: 1 800 498 5351

EMEA: 00 800 70002222

Asia-Pacific: 001 800 03061910

For additional numbers, click [here](#).